

IT83 Series Indoor Monitor User Manual

About This Manual

Thank you for choosing Akuvox's IT83 series indoor monitor. This manual is intended for end users, who need to use and configure the indoor monitor. This manual provides an introduction of all functions and features of the product. It is suitable for 83.31.2.3xx version. Please visit Akuvox forum or consult technical support for any new information or latest firmware.

Note: Please refer to universal abbreviation form in the end of manual when meet any abbreviation letter.

Content

1. Product Overview.....	1
1.1. Product Description.....	1
1.2. Connector Introduction.....	2
2. Daily Use.....	3
2.1. Starting.....	3
2.2. Making a Call.....	5
2.2.1. Calling from Call List.....	5
2.2.2. Calling from All Call.....	5
2.2.3. Calling from Missed Call.....	6
2.2.4. Calling from Device.....	7
2.2.5. Calling from LocalPhoneBook.....	7
2.2.6. Calling from Keypad.....	8
2.3. Receiving a Call.....	8
2.3.1. Receive an Incoming Call.....	8
2.3.2. During the session.....	9
2.4. Monitor.....	9

2.4.1. Checking the Monitor.....	10
2.5. Message.....	11
2.5.1. Text Message.....	11
2.5.2. Creating a Message.....	12
2.5.3. Deleting a Message.....	13
2.6. Arming.....	14
2.6.1. Arming Mode.....	14
2.6.2. Disarm Code.....	15
2.6.3. Alarm Log.....	16
2.6.4. Status.....	16

1. Product Overview

1.1. Product Description

IT83X is an Android SIP-based with smooth touch-screen indoor monitor. It can be connected with Akuvox door phone for audio/video communication, unlocking and monitoring.

Residents can communicate with visitors via audio/video call, and it supports to unlock the door remotely. It is more convenient and safer for residents to check the visitor's identity through its video preview function.

IT83X are often applied to scenarios such as villas, apartments and buildings.

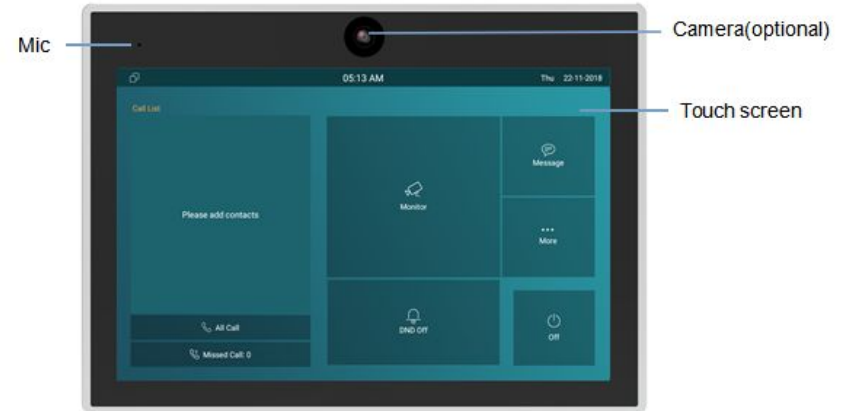

1.2. Connector Introduction

Ethernet (POE): Ethernet (POE) connector which it can provide both power and network connection.

RJ45 (PON): Share the network access from Ethernet (POE) port, and for PC and other equipments connection.

12V/GND: External power supply terminal if POE is not available.

RS485A/B: RS485 terminal.

Bell/GND: Connect a simple two-wire door bell.

Relay A/B (NO/COM/NC): Relay control terminal.

IO1- IO8/GND: Connect with different alarm detectors for 8 security zones.

Note: The general indoor monitor interface diagram is only for reference.

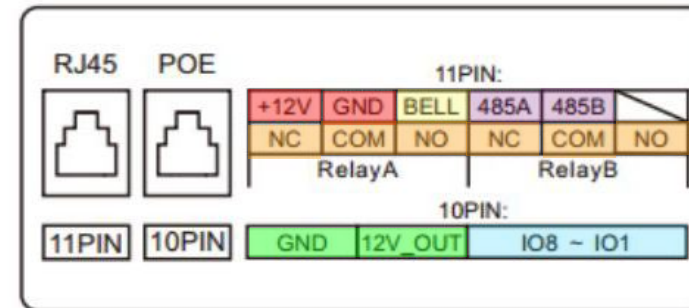

Figure 1.2-1 IT83X interface

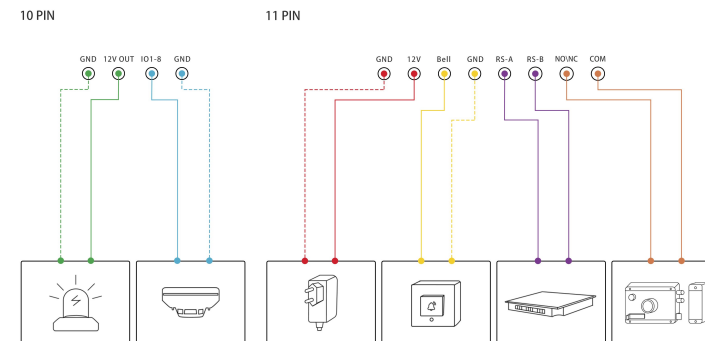

Figure 1.2-2 General interface

2. Daily Use

2.1. Starting

When booting IT83X first time, users need to choose a suitable way to connect to network, wireless or wire.

To choose a proper device mode according to specific application scenarios. IT83X supports 3 modes, including **Cloud**, **Discovery** and **SDMC**. It only pop up Cloud Mode and Discovery Mode for users choosing. Tap **Skip** if users are adopting SDMC mode. Discovery mode is default mode if you don't choose any device mode.

Discovery mode: It is a plug and play configuration mode. Akuvox devices will configure themselves automatically when users power on the devices and connect them to network. It is super time-saving mode and it will greatly bring users convenience by reducing

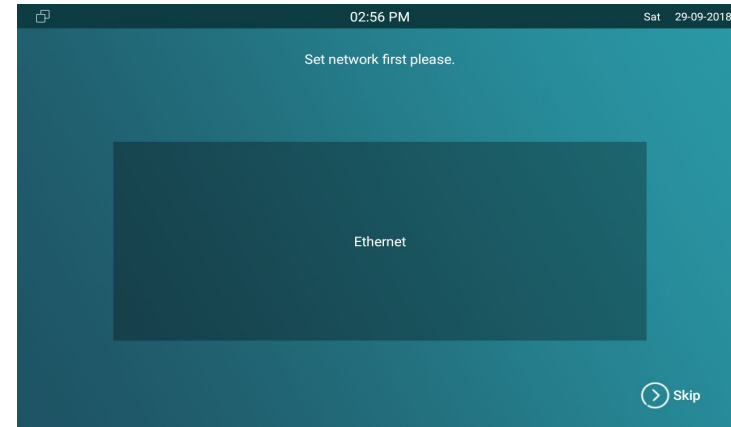

Figure 2.1-1 Network selection

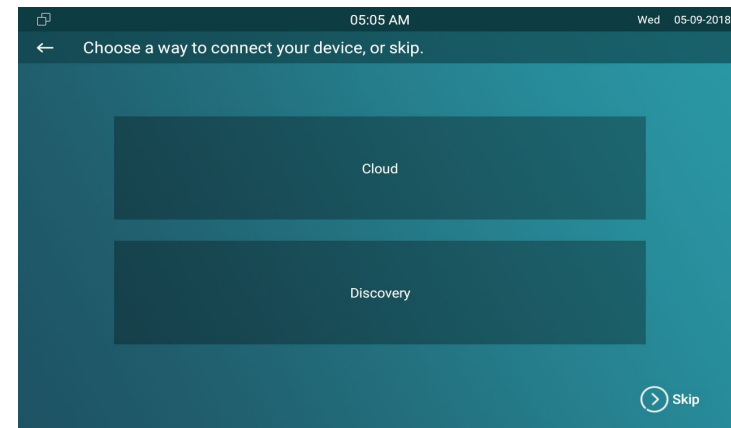

Figure 2.1-2 Device mode selection

manual operations. This mode do not need to be done any configurations previously by the administrator.

Cloud mode: Akuvox Cloud is an all in one management system. Akuvox Cloud is the mobile service that allows audio, video, remote access control between smart phones and Akuvox intercoms. All configurations in the device will be issued automatically from cloud. If users decide to use Akuvox cloud, please contact administrator, who will help to configure related settings before using.

SDMC mode: SDMC is a center management software which is suitable for managing a community in LAN. The device will get settings from SDMC automatically.

2.2. Making a Call

There are 6 ways to establish VOIP calls by IT83X.

2.2.1. Calling from Call List

In the home page, choose a number from **Call List** to make a call.

- Scroll up or down the **Call List** to choose the contact that users want to call.

Note: In Cloud or SDMC mode, the **Call List** of IT83X will be issued from the system.

2.2.2. Calling from All Call

In the home page, it could call multiple indoor monitors if they are set under the same multicast address. During the session, IT83X is listened by other indoor monitors.

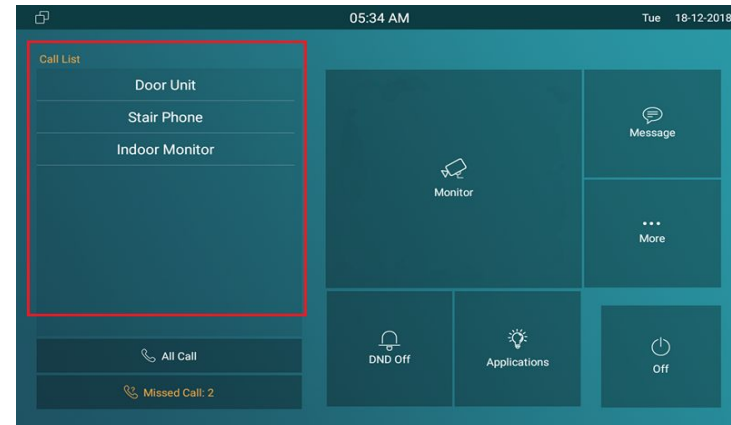

Figure 2.2.1-1 Call from call list

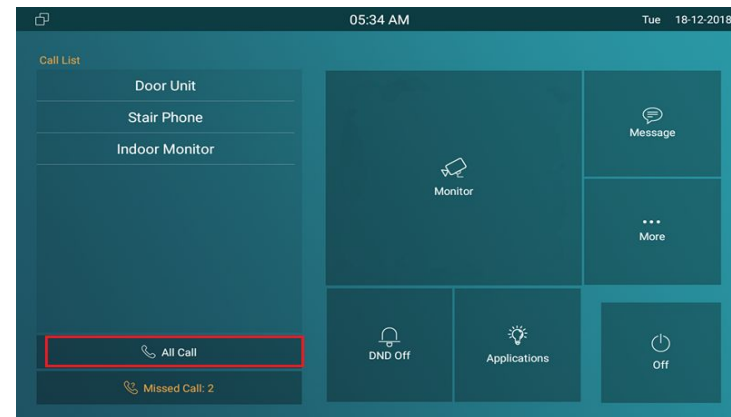

Figure 2.2.2-1 Call from all call

- Tap **All Call** icon to call other indoor monitors which are set in the same multicast group.

2.2.3. Calling from Missed Call

In the home page, missed call indicates how many calls that users missed (1 missed call for an example). Missed call could be treated as a brief call log.

- Tap **Missed Call** icon ① to view the calls that were not answered before.
- Choose the contact on the call list ② which users want to call out.
- Click account above the keypad ③ to switch accounts to make a call.
- Choose **Audio** ④ or **Video** ⑤ mode to call out.

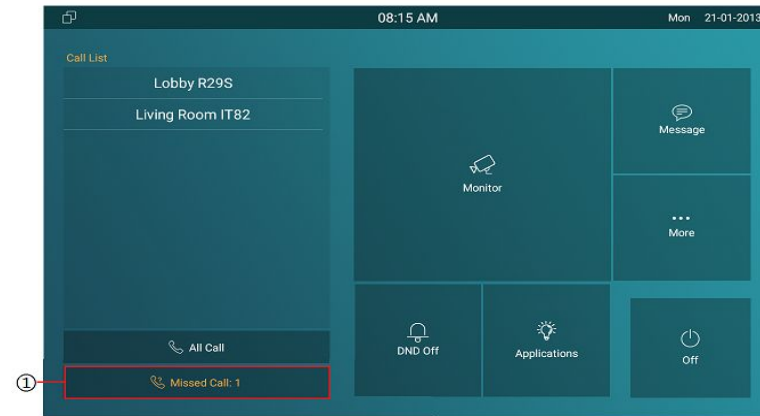

Figure 2.2.3-1 Call from miss call

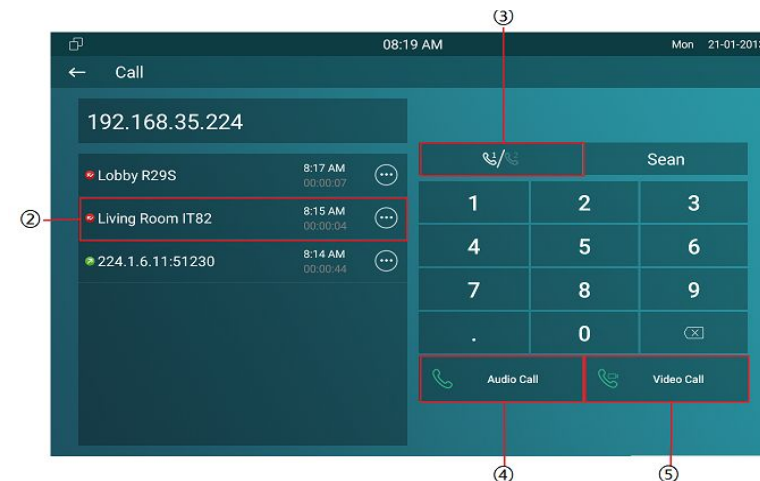

Figure 2.2.3-2 Call from miss call

2.2.4. Calling from Device

It will display the devices connected with IT83X on the contact interface. On the device, go to **More - Contact**.

- Click **Update** ① to synchronous the contact automatically.
- Choose a device ② which users want to call.
- Choose **Audio** ③ or **Video** ④ mode to call out.

Note: Only under Discovery mode, users need to press **Update** key manually.

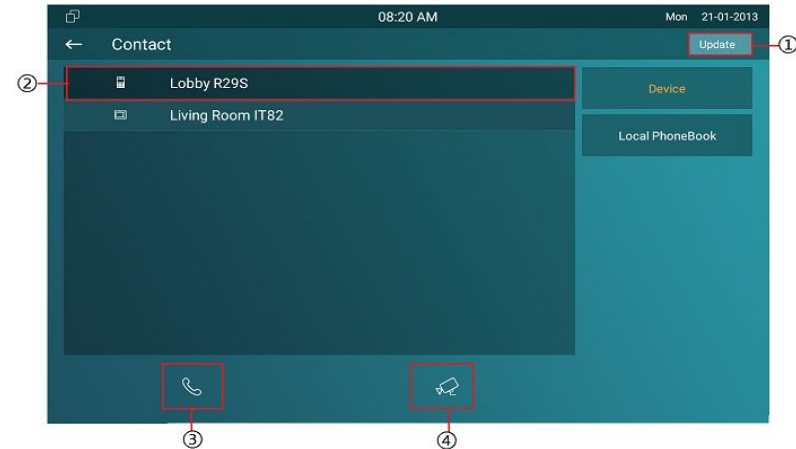

Figure 2.2.4-1 Call from device

2.2.5. Calling from LocalPhoneBook

On the device, go to **More - Contact** to enter the **Local PhoneBook** interface to make a call.

- IT83X supports fuzzy matching query ①. To search the list by entering number or alphabet.
- Scroll up or down to select contact ② that users want to call.

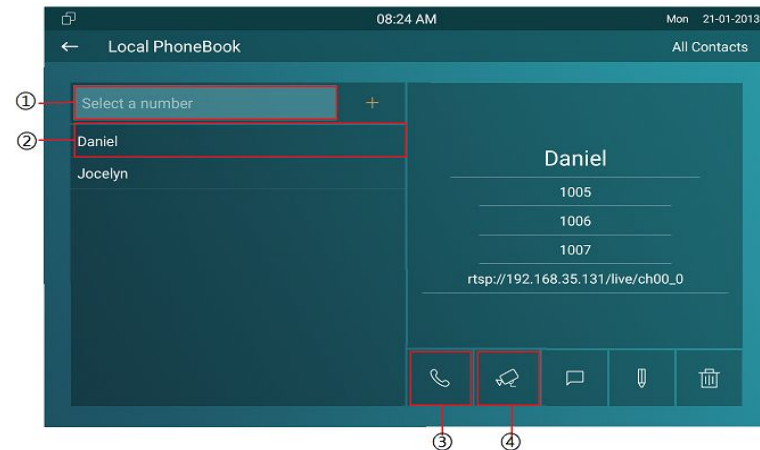

Figure 2.2.5-1 Call from local phonebook

- Choose **Audio** ③ or **Video** ④ mode to call out.

2.2.6. Calling from Keypad

On the device, go to **More - Call** to get access to keypad.

- Click account icon ① above the keypad to switch accounts to make a call.
- Input the SIP account /IP address to the keypad ② to call the corresponding devices or soft phone.
- Choose **Audio** ③ or **Video** ④ mode to call out.

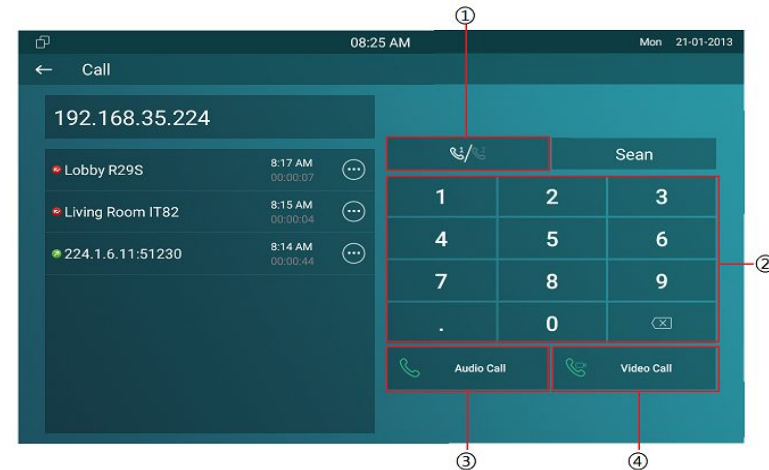

Figure 2.2.6-1 Call from keypad

2.3. Receiving a Call

2.3.1. Receive an Incoming Call

IT83X supports to preview the caller when it receives an incoming call from door phone.

- Tap **Answer** to pick up the incoming call.

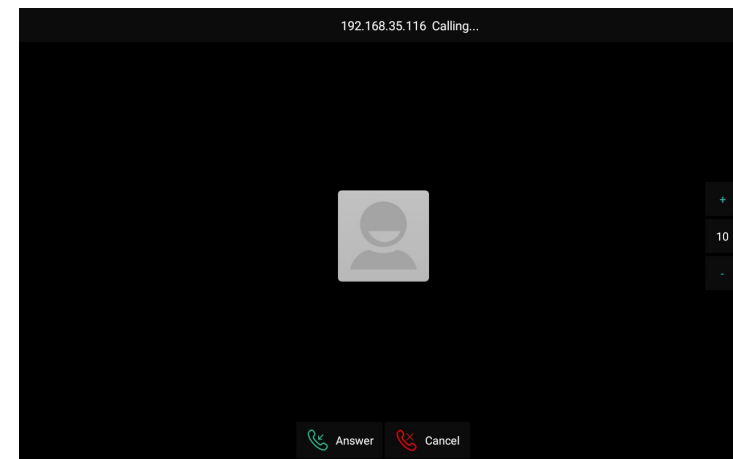

Figure 2.3.1-1 Incoming call

- Tap **Cancel** to reject the incoming call. Press “+” or “-” of the volume on the right side to adjust the ring tone volume.

2.3.2. During the session

- Tap **Unlock** to open the corresponding door (if the call is from outdoor unit).
- Tap **Capture** to take a screen shot of current interface.
- Tap **Mute** to eliminate the voice on IT83X’s side.
- Tap **Switch** to switch from video call to audio call or vice versa.
- Tap **Cancel** to hang up the current call.

2.4. Monitor

Monitor feature enables users to view the real-time video from IP cameras or door phones anytime. Click **Monitor** in the home page.

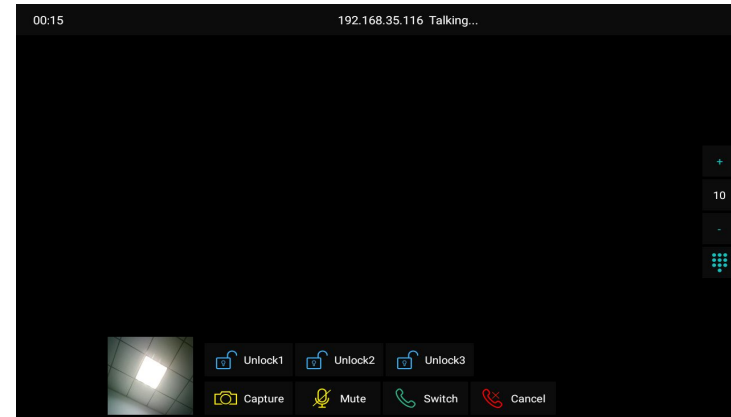

Figure 2.3.2-1 During session

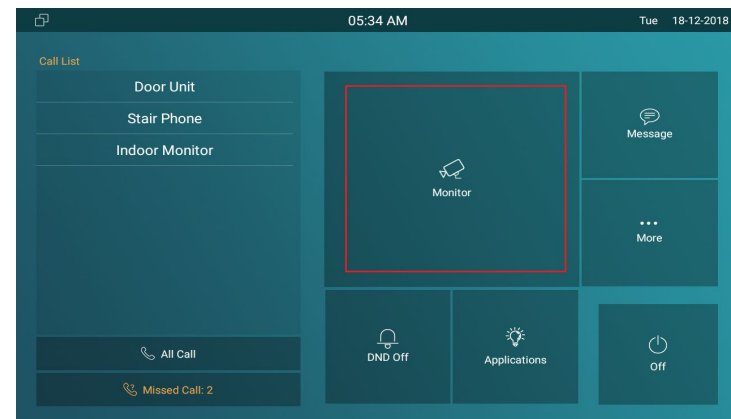

Figure 2.4-1 Monitor

2.4.1. Checking the Monitor

Choose the outdoor devices from the list. The real-time video from the door phone or IP camera will show in the screen .

- Press **Unlock** to open the door which is connected with door phone.
- Press **Capture** to take a screen shot of current interface.
- Press **Cancel** to exit the monitoring.
- Press **List button** in the bottom right corner to wake the outdoor video list.
- Press the **Monitor list** in the right side to choose the outdoor videos.

Note: Only under Discovery mode, users need to press **Update** key manually to synchronous the devices which is in the same node.

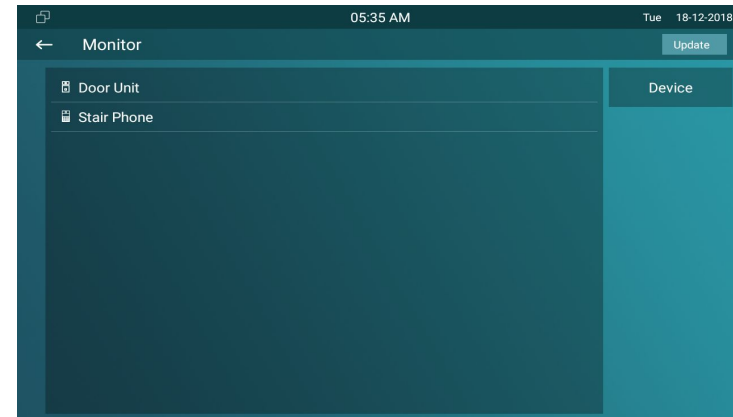

Figure 2.4.1-1 Live view list

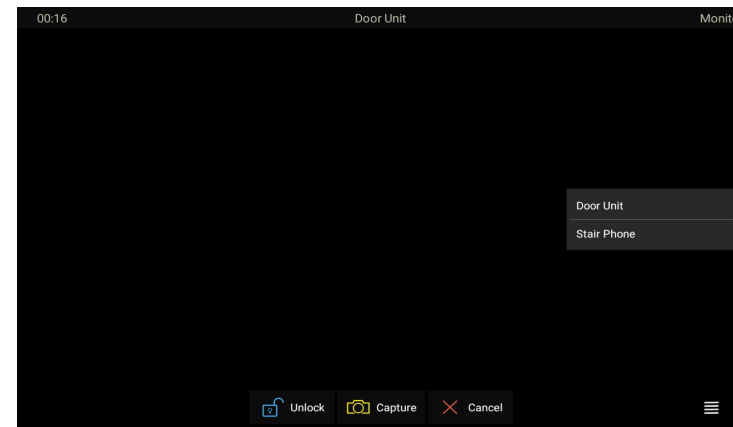

Figure 2.4.1-2 Live view video

2.5. Message

Message ① indicates how many messages are unread (An unread message for an example). Or directly enter the message interface to manage.

2.5.1. Text Message

- Tap **Message** ① on the main interface to view the unread message.
- Tap the unread message ② to view the message in details.

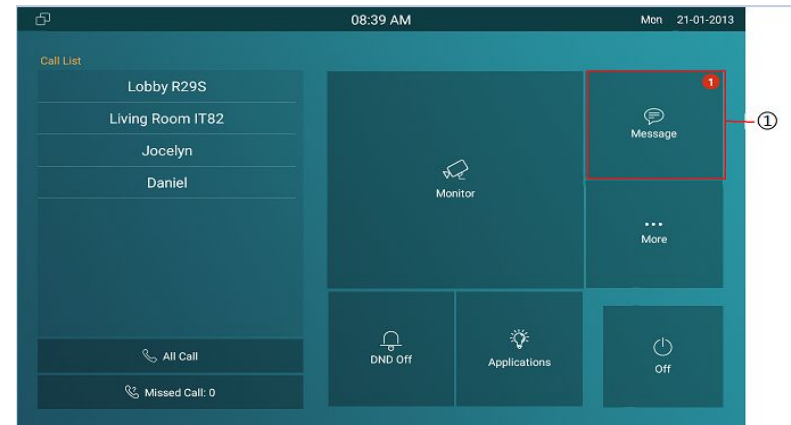

Figure 2.5 -1 Message

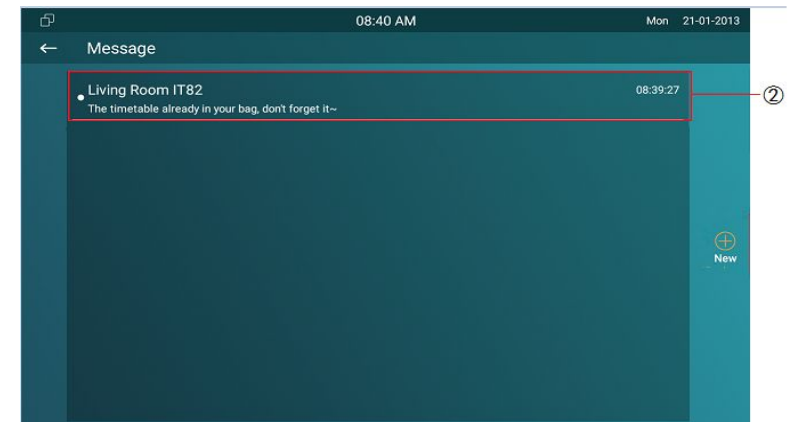

Figure 2.5.1-1 Text message

2.5.2. Creating a Message

- Press **New** key ① to create a new message.
- Enter the destination number manually ② or choose the contact from the **contact list** ③ or select the device quickly from the below list ④ .
- Choose the **frequently used message** ⑤ , such as “Hello,” “Help.” Or input the message content which users want to send ⑥.
- Press **Send** key ⑦ to send.

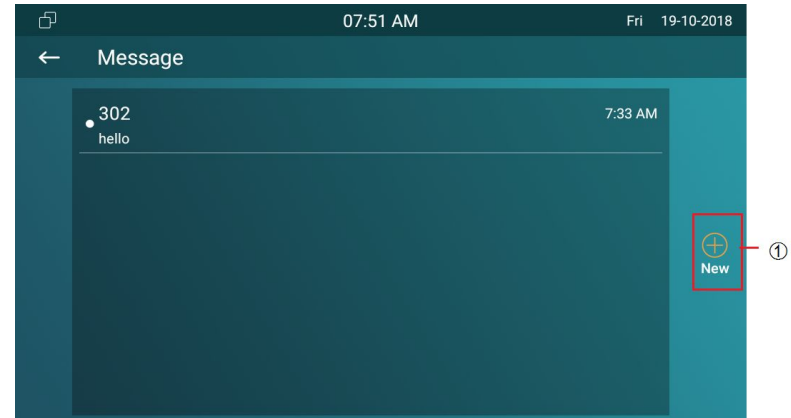

Figure 2.5.2-1 Create message

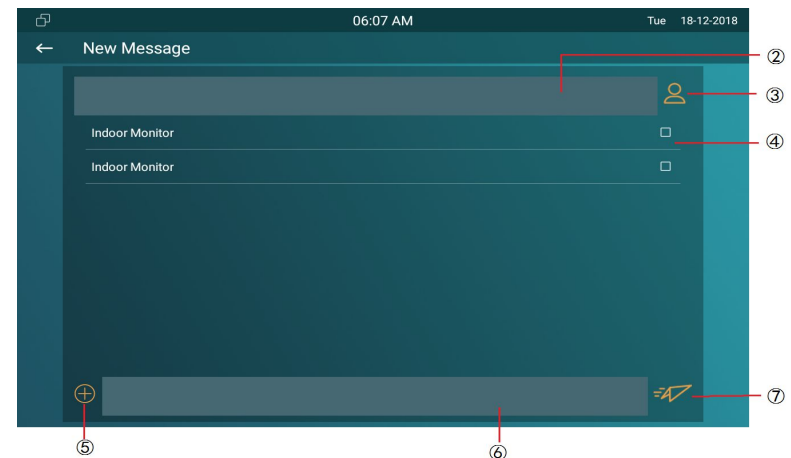

Figure 2.5.2-2 Create message

2.5.3. Deleting a Message

- Long press the message ① to select it.
- Click **Select All** ② to select all message in the message lists.
- Click **Delete** ③ to delete the messages have been selected.
- Click **Cancel** ④ to cancel the operation.
- Click **Back** icon ⑤ to exit the message interface.

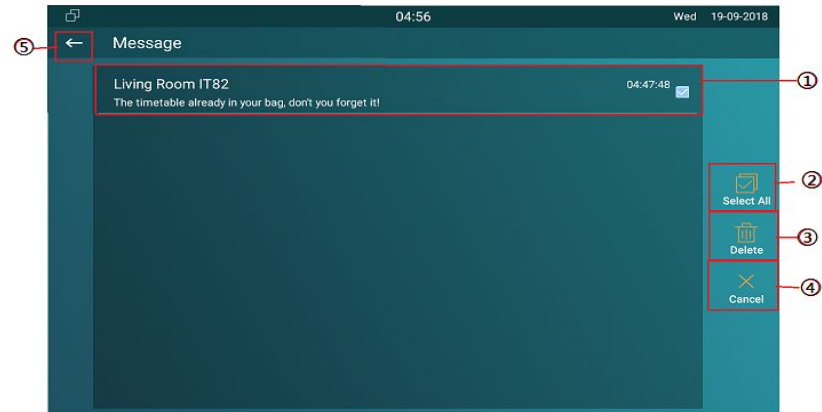

Figure 2.4.2-1 Delete message

2.6. Arming

Tap **Arming** to enter the Arming interface. Arming feature is not displayed by default. Users can ask administrator to enable it.

IT83X supports 4 modes, including **Home** mode, **Night** mode, **Away** mode and **Disarmed** mode.

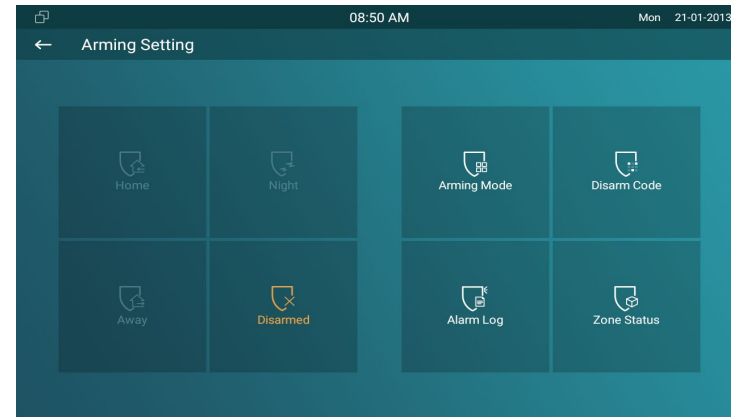

Figure 2.6-1 Arming

2.6.1. Arming Mode

Go to **Arming - Arming mode**. Users can see all of the 8 zones and corresponding sensor types. Slide down to check more information in this interface.

- Adjust **Defence delay time**. It means when users change the arming mode from other modes, there will be 90 seconds delay time to get activated.
- To setup the **Alarm delay**. It means when the sensor triggered, there will be 90 seconds delay time to announce the

A screenshot of the 'Arming Mode' interface. It shows a table with 8 zones. The table has columns for Zone, Location, Zone Type, Defence delay, Alarm Delay, and Status. The 'Home' mode is selected and highlighted in orange. The table data is as follows:

Zone	Location	Zone Type	Defence delay	Alarm Delay	Status
Zone1	Guest room	Doorbell	90s delay	90s delay	24H
Zone2	Bedroom	Infrared	90s delay	90s delay	Disable
Zone3	Bedroom	Infrared	90s delay	90s delay	Disable
Zone4	Bedroom	Infrared	90s delay	90s delay	Disable
Zone5	Bedroom	Infrared	90s delay	90s delay	Disable
Zone6	Bedroom	Infrared	90s delay	90s delay	Disable
Zone7	Bedroom	Infrared	90s delay	90s delay	Disable
Zone8	Bedroom	Infrared	90s delay	90s delay	Disable

At the top, there is a status bar with the time '08:49 AM' and the date 'Mon 21-01-2013'. A back arrow is visible in the top left corner, and a checkmark icon is in the top right corner.

Figure 2.6.1-1 Arming mode

notification.

- The **Status** in the corresponding zone means whether the zone is available or not.
- Press **Save** in the top right corner to save the modification.

2.6.2. Disarm Code

Go to **Arming - Disarm Code** to enter the disarm code settings interface. Users can modify the disarm code here.

- Enter the **original disarm code** ① first, and it is 0000 by default.
- Enter the **new disarm code** ②.
- Enter the new disarm code again ③ for confirming.
- Press **Save** to save the modification.

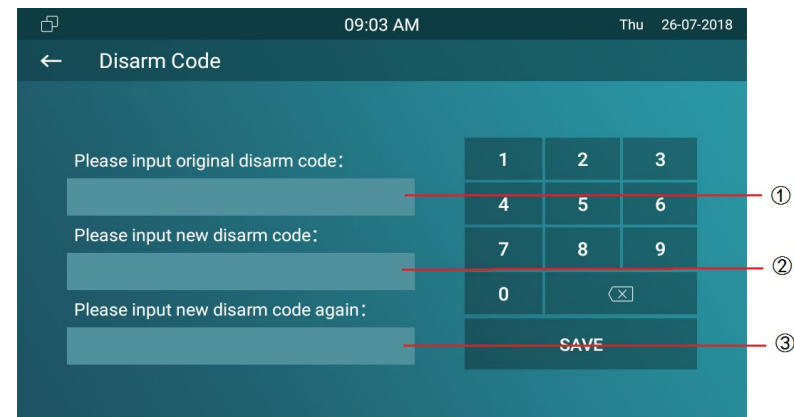

Figure 2.6.2-1 Disarm code

2.6.3. Alarm Log

Go to **Arming - Alarm Log** to enter the alarm log interface. Users can check the alarm log, including “location,” “zone,” “zone type” and “alarm time.”

- Hold an **alarm log** ① and it will show up delete prompt.
- Press **Select All** ② to delete all alarm log or select a part of existed messages then click **Delete** ③.
- Press **Cancel** ④ to cancel to deletion.

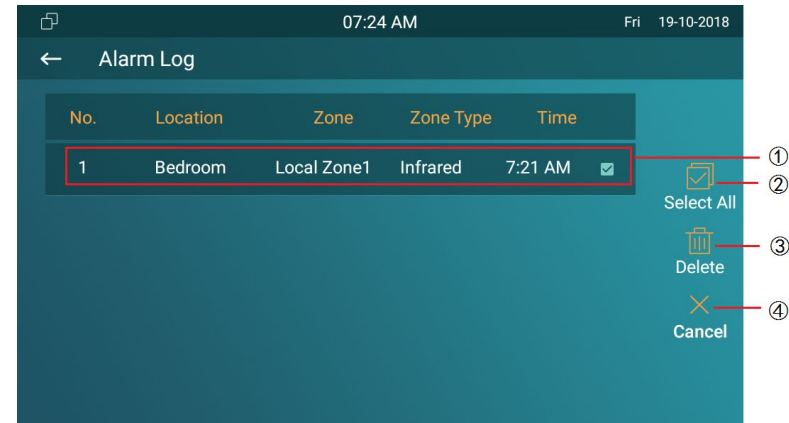

Figure 2.6.3-1 Alarm log

2.6.4. Status

Go to **Arming - Zone Status** to enter the zone status interface. Users can check the status of zones, including “location,” “zone type,” “trigger mode” and “status.”

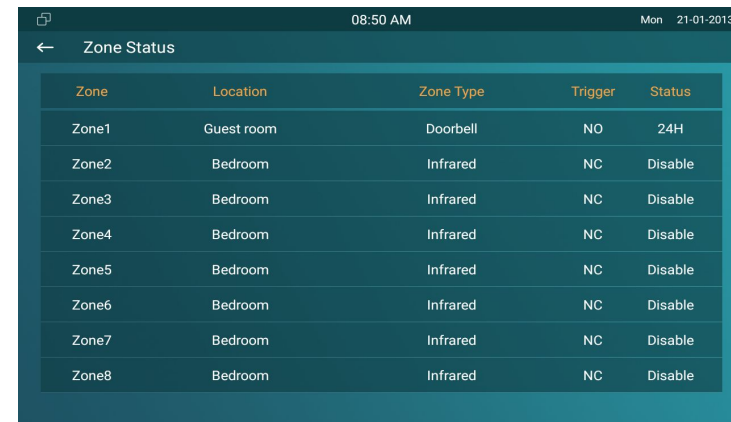

Figure 2.6.4-1 Alarm status

Abbreviations

ACS: Auto Configuration Server

Auto: Automatically

AEC: Configurable Acoustic and Line Echo Cancelers

ACD: Automatic Call Distribution

Autop: Automatical Provisioning

AES: Advanced Encryption Standard

BLF: Busy Lamp Field

COM: Common

CPE: Customer Premise Equipment

CWMP: CPE WAN Management Protocol

DTMF: Dual Tone Multi-Frequency

DHCP: Dynamic Host Configuration Protocol

DNS: Domain Name System

DND: Do Not Disturb

DNS-SRV: Service record in the Domain Name System

FTP: File Transfer Protocol

GND: Ground

HTTP: Hypertext Transfer Protocol

HTTPS: Hypertext Transfer Protocol Secure

IP: Internet Protocol

ID: Identification

IR: Infrared

LCD: Liquid Crystal Display

LED: Light Emitting Diode

MAX: Maximum

POE: Power Over Ethernet

PCMA: Pulse Code Modulation A-Law

PCMU: Pulse Code Modulation μ -Law

PCAP: Packet Capture
PNP: Plug and Play
RFID: Radio Frequency Identification
RTP: Real-time Transport Protocol
RTSP: Real Time Streaming Protocol
MPEG: Moving Picture Experts Group
MWI: Message Waiting Indicator
NO: Normal Opened
NC: Normal Connected
NTP: Network Time Protocol
NAT: Network Address Translation
NVR: Network Video Recorder
ONVIF: Open Network Video Interface Forum

SIP: Session Initiation Protocol
SNMP: Simple Network Management Protocol
STUN: Session Traversal Utilities for NAT
SMTP: Simple Mail Transfer Protocol
SDMC: SIP Devices Management Center
TR069: Technical Report069
TCP: Transmission Control Protocol
TLS: Transport Layer Security
TFTP: Trivial File Transfer Protocol
UDP: User Datagram Protocol
URL: Uniform Resource Locator
VLAN: Virtual Local Area Network
WG: Wiegand

Contact us

For more information about the product, please visit us at www.akuvox.com or feel free to contact us by

Sales email: sales@akuvox.com

Technical support email: techsupport@akuvox.com

Telephone: +86-592-2133061 ext.7694/8162

We highly appreciate your feedback about our products.

